

# God Made Me

Name \_\_\_\_\_

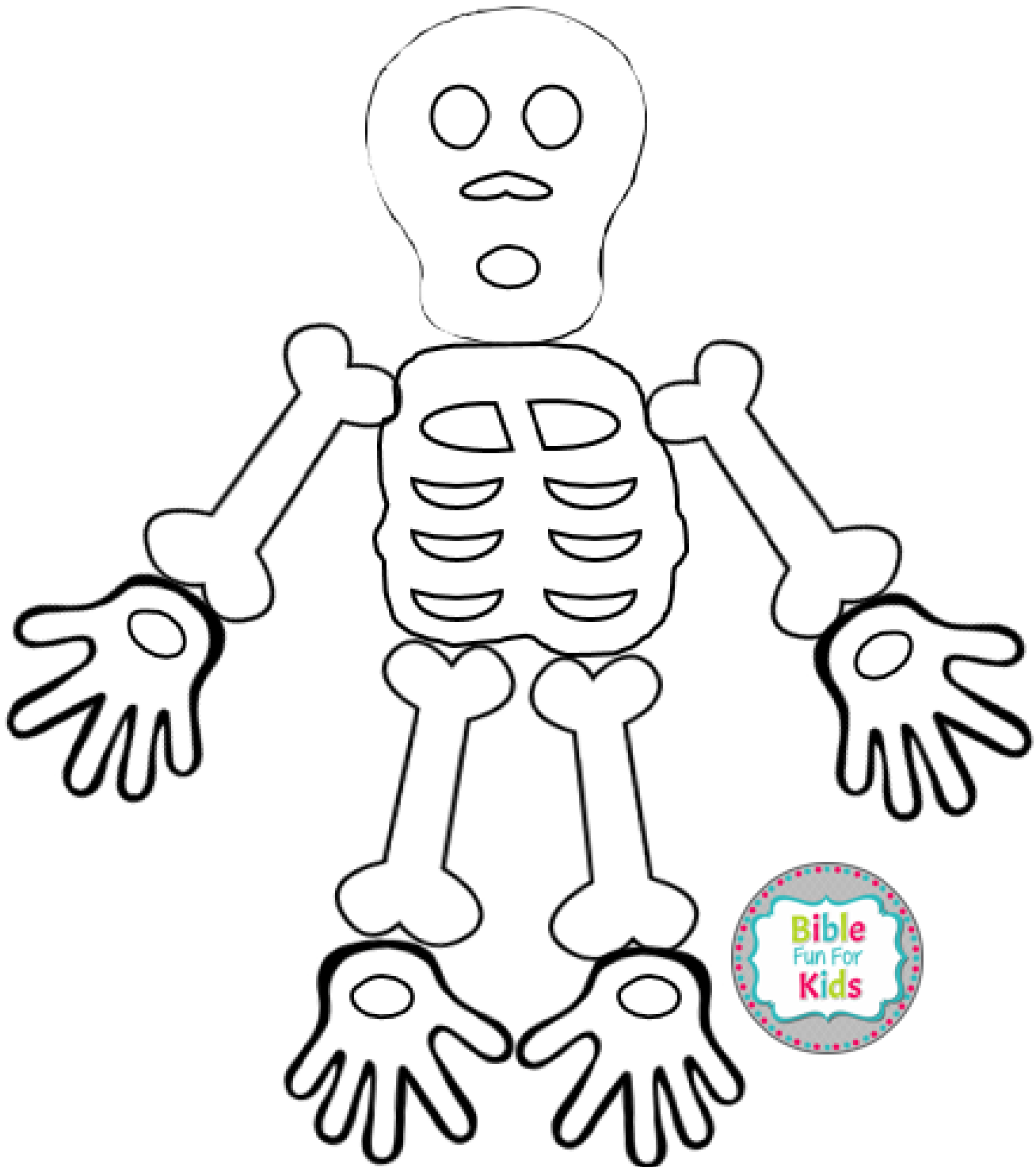

God said, "I will bring the people back to the land of Israel."

Help the people get to Israel.

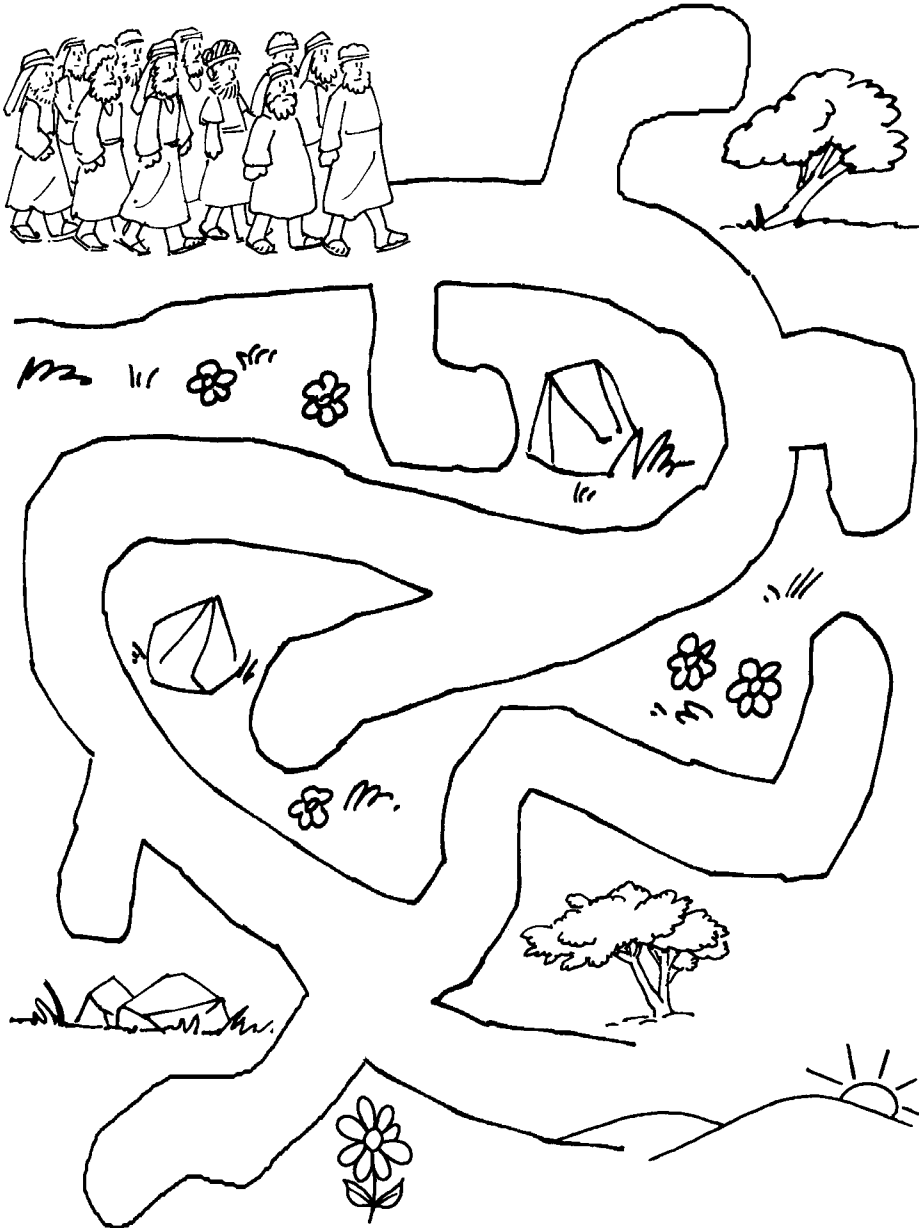

# Children's Worship Bulletin™



Ages 3+

March 29, 2020 • Ezekiel 37:1-14

## The Vision of the Bones

God sent Ezekiel a vision. In it, Ezekiel was in a valley. The valley was full of dry bones.

Connect the dots.  
A B C D E F G H I J K L M

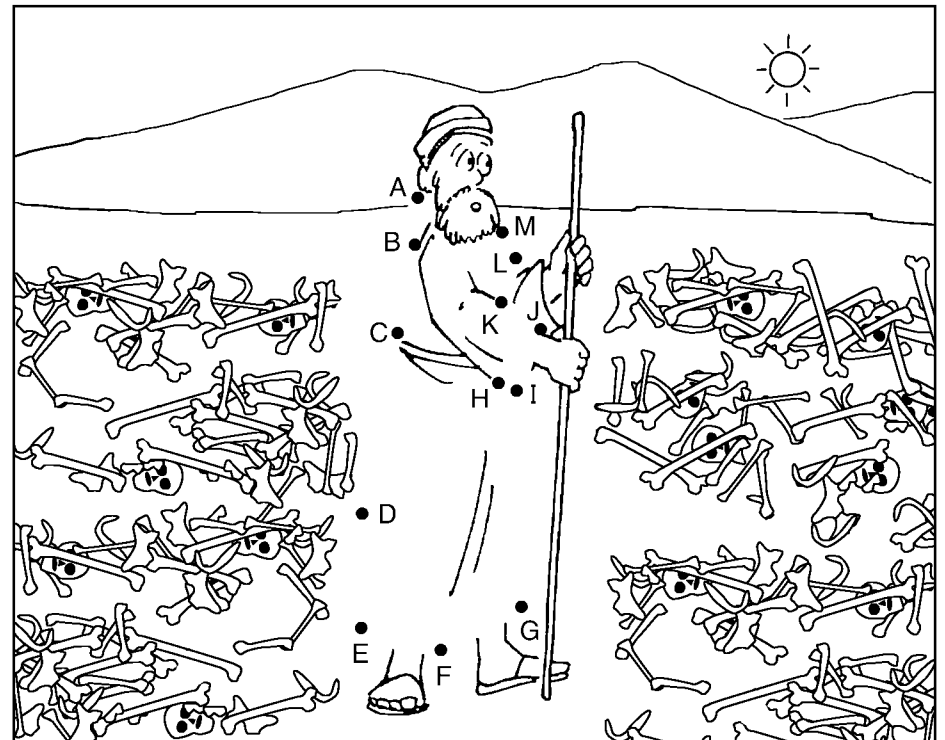

Israel was like dry bones.  
The people said, "Our hope is gone."

Use the code to fill in the missing letters.

e =       i = 

o =       u = 

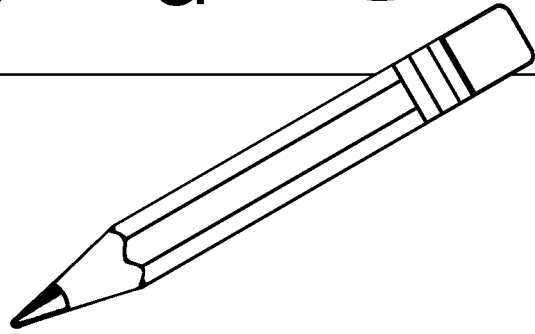

"O \_ r h \_ p \_



\_ s g \_ n \_ ."



God told Ezekiel to speak to the bones.  
"They will live again," God said.

Match the shapes below.

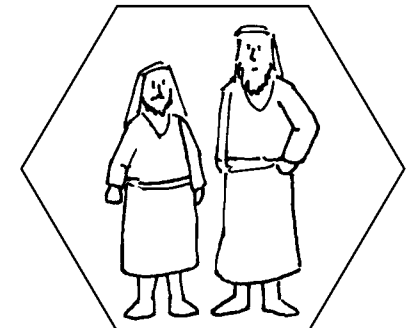
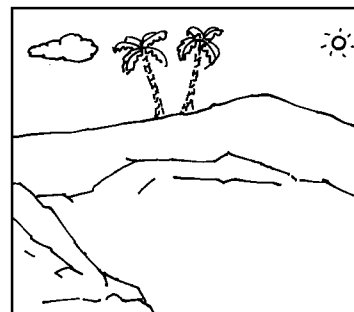
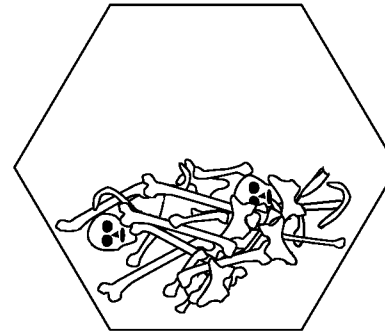
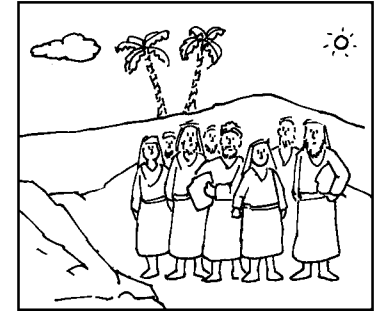

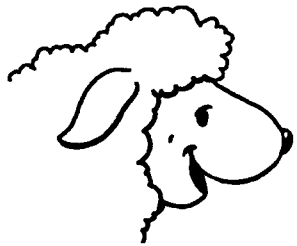

What did God say the dried bones He had brought back to life represented? What would He do?

Match the pieces of the picture, writing the words to find what God said.

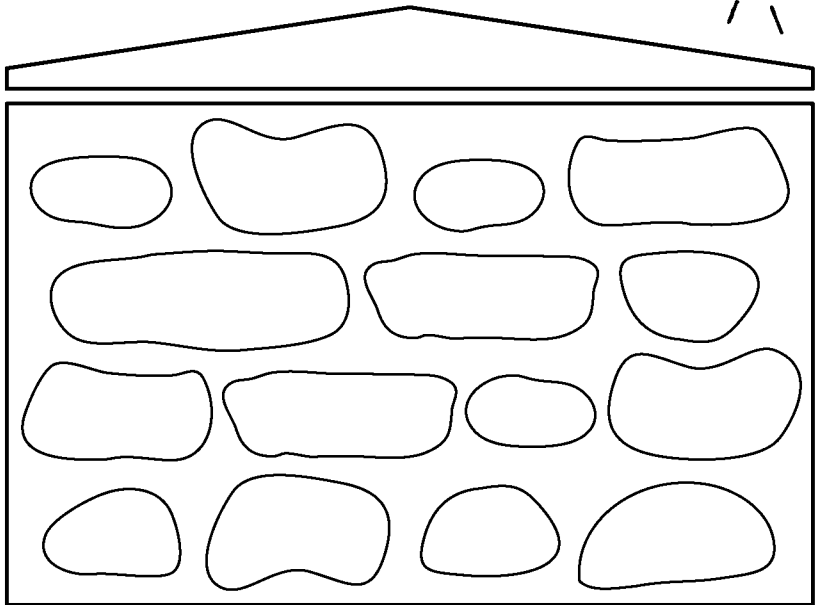
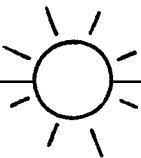

whole house   land   bones are   I will  
 in your   back to the   I will   "These  
 the   people ...   bring you   settle you  
 of Israel ... O My   own land."   of Israel ...

# Children's Worship Bulletin™

Ages 7+

March 29, 2020 • Ezekiel 37:1-14

## The Vision of the Bones

God sent Ezekiel a vision. In it, Ezekiel was in a valley full of bones. The bones were very dry. What did God ask Ezekiel?

Cross out the words containing D, G, K, P, R, U, W or Y. Then write the remaining words in order in the spaces below.

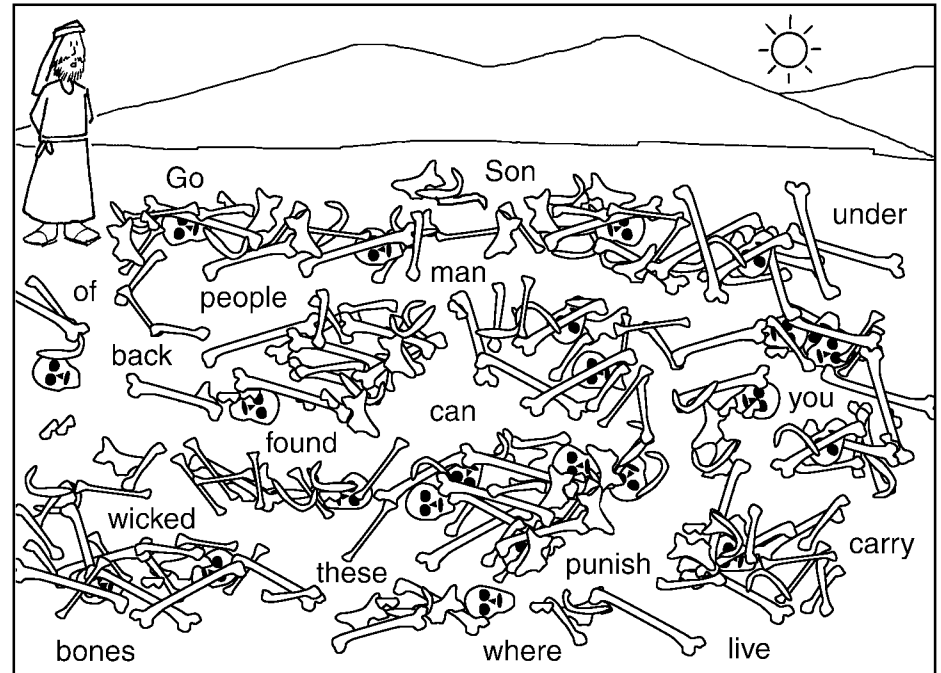

God asked, " \_\_\_\_\_ , \_\_\_\_\_  
 \_\_\_\_\_ ?"

Then God said to Ezekiel, "Prophecy to these bones and say to them, 'Dry bones, hear the word of the Lord!'"  
 What was Ezekiel commanded to speak to the bones?

Complete the list of body parts using the descriptions given.  
 Then, using these numbered letters, complete the passage.

- Used for breathing 1 2 3 4 5
- Controls the body 6 7 8 9 10
- Called "the window of the body" 11 12 13
- Bone for opening and closing mouth 14 15 16
- Enable feeling pain n  
17 18 19 20 21 22
- Spine is sometimes also called 23 24 25 26 27 28 29 30
- Used for walking and standing (singular) 31 32 33
- Part used for speaking and eating 34 35 36 37 38
- Unnecessary part of digestive system 39 40 41 42 43

" 4 32 41 16 9 1 1 15 33 37 8 25 38

33 11 17 41 35 17 5 33 32 12 35 36 8 10 41

34 24 26 21 31 1 30 5 38 25 32 34 11

36 39 35 29 12 32 36 8 17 41 25 32 20 13 19

12 28 36 16 9 37 38 5 26 42 10 38 30

16 9 1 1 39 36 37 23 7 21 24 33 38 9 29

12 35 36 24 17 41 12 35 36 16 9 1 1

25 32 34 40 33 35 1 9 31 40 33 38 30 29

12 32 36 16 9 1 1 26 10 35 16 33 38 8 33

4 28 41 42 22 37 38 18 1 35 7 41"

When Ezekiel prophesied to the bones, the bones came together. Flesh appeared on them and skin covered them. But there was no breath in them. What did God say to do?

Move the columns into the right places to complete the passage.

5		2		3		11		19		20
h	17	r	13	o	8	o	22	e	7	a
t	b	a	t	y	y	'C	h.	m	s	
f	r	h	m	e	i	i		r		e
b		n	d	d	r	e	t	h	u	e
n,		l	i	a	a		e	y	e	
	m		h		h		i		t	

1	2	3	4	5	6	7	8	9	10	11	12	13	14	15	16	17	18	19	20	21	22	23	24
"P		p	e		t		h	e		r		t											
S			o		t,		o	e	f	o													
t			o		w	n	s,	O	b	a	h,												
a			r		t	h		n	t	o	t	s											
s		i			a	t	t	e	y		a		l	v	e."								

So Ezekiel prophesied and breath entered them; they came to life and stood up on their feet.

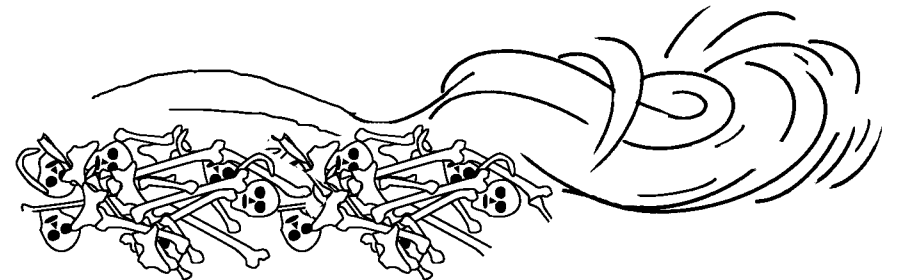

Challenge families to memorize one Bible verse per day together. Here are some short, impactful ones to get you started:

- 2 Corinthians 5:7
- Luke 11:9
- Hebrews 11:1
- 1 John 4:19
- Luke 1:37
- 1 Corinthians 10:31
- James 1:22
- Psalm 34:18
- Hebrews 2:18
- Proverbs 30:5
- Psalm 46:1



What did God say the dried bones He had brought back to life represented? What would He do?

Match the pieces of the picture, writing the words to find what God said.



"These bones are the whole house of Israel ... O My people ... I will bring you back to the land of Israel. I will settle you in your own land."

whole house land bones are I will in your back to the I will "These the people ... bring you settle you of Israel ... O My own land." of Israel ...

# Children's Worship Bulletin™

Ages 7-12

March 29, 2020 • Ezekiel 37:1-14

## The Vision of the Bones

God sent Ezekiel a vision. In it, Ezekiel was in a valley full of bones. The bones were very dry. What did God ask Ezekiel?

Cross out the words containing D, G, K, P, R, U, W or Y. Then write the remaining words in order in the spaces below.

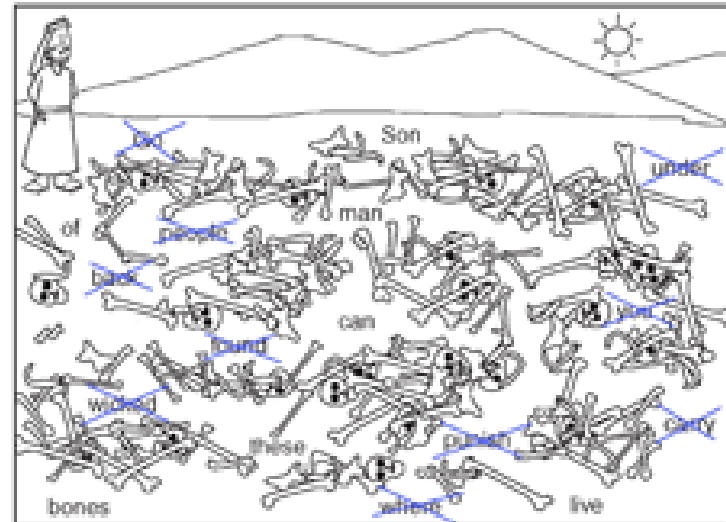

God asked, "Son of man, can these bones live?"

Then God said to Ezekiel, "Prophesy to these bones and say to them, 'Dry bones, hear the word of the Lord!' What was Ezekiel commanded to speak to the bones?"

Complete the list of body parts using the descriptions given. Then, using these numbered letters, complete the passage.

- Used for breathing l u n g s
- Controls the body b r a i n
- Called "the window of the body" e y e
- Done for opening and closing mouth j a w
- Enable feeling pain n e r v e s
- Spine is sometimes also called b a c k b o n e
- Used for walking and standing (singular) f o o t
- Part used for speaking and eating m o u t h
- Unnecessary part of digestive system a p p e n d i x

God will attach  
tendons to you and  
make flesh come  
upon you and cover  
you with skin. He  
will put breath in  
you and you will  
come to life. Then  
you will know that  
God is the Lord.

When Ezekiel prophesied to the bones, the bones came together. Flesh appeared on them and skin covered them. But there was no breath in them. What did God say to do?

Move the columns into the right places to complete the passage.

5	17	2	13	3	8	11	22	19	7	20
h	b	r	t	o	y	o	h	e	s	a
i	r	a	m	y	i	o	m	r	u	e
i		n	d	e	r	i	t	h	e	
b		n	i	a	a	e	e	y	e	
n	m	i	h	a	h	i	i	y	t	

	1	2	3	4	5	6	7	8	9	10	11	12	13	14	15	16	17	18	19	20	21	22	23	24
P	r	o	p	h	e	s	y		t	o	t	h	e		b	r	e	a	t	h				
S	a	y		t	o		i	t		'	C	o	m	e		t	r	o	m					
t	h	e		f	o	u	r		w	i	n	d	s		O		b	r	e	a	t	h		
a	n	d		b	r	e	a	t	h	e		i	n	t	o		t	h	e	s	e			
s	l	a	i	n		t	h	a	t		t	h	e	y		m	a	y						

So Ezekiel prophesied and breath entered them; they came to life and stood up on their feet.

